

# BASO 1.5 DIRECT

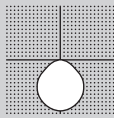

## PERFORMANCE

- Up to 98lm/W efficiency
- 400 / 550lm/ft
- CRI > 80 & CRI > 90
- Damp rated



## MOUNTING

Ceiling

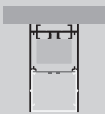

Pendant

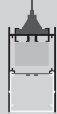

## PATTERNS



\*X Shapes



Angular



\*Wall to Ceiling



Rectangular



\*T Shapes

For customization, please contact customer service

## FIELD-CUTTABLE FLEX

Down to 1/16"



[link to video](#)

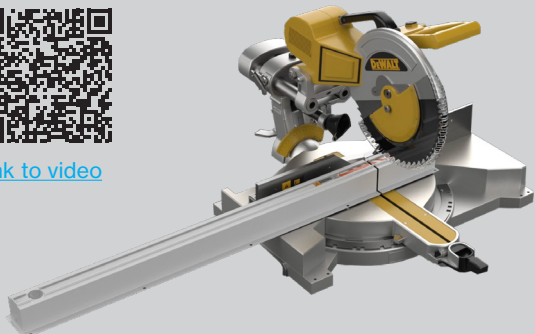

## Catalog Number Example

BASO 1.5-SUR-WH-OP-27K-C80-UNV-010V-SEN-0400LF-NLC-ST-24IN

### A RANGE

BASO 1.5      B A S O 1 . 5

### B MOUNTING

**CS** Surface      S U R  
 Surface in-line ACT T-BAR    S A T  
 Surface in-line ACT SLOT    S A S  
 Surface ACT center tile    S A C  
**CS** Pendant      P D T  
 Pendant in-line ACT T-BAR   P A T  
 Pendant in-line ACT SLOT   P A S  
 Pendant ACT center tile    P A C

pendant suspension set includes cable suspension and one white power feeder with a white junction box cover

Wall mounted      W A L

for black power feeds or junction box covers, please contact customer service

### C COLOR

**CS** White      W H  
**CS** Black      B L  
 Gray      G R  
 Custom color RAL      X X

### D LENS

HP opal cover      O P

### E CCT

2700K      2 7 K  
**CS** 3000K      3 0 K  
**CS** 3500K      3 5 K  
 4000K      4 0 K

### F CRI

CRI > 80      C 8 0  
 CRI > 90      C 9 0

### G VOLTAGE

120V / 277V      U N V

### H DIMMING

**CS** 0-10V 1%      0 1 0 V  
 Lutron EcoSystem      L E S 1  
 Quantum, Vive, GRAFIK Eye, HomeWorks  
 Power over ethernet      P O E C  
 consult customer service for compatibility  
 Custom dimming      X X X X  
 consult customer service for compatibility

### I SENSOR (optional)

Integrated Sensor      S E N  
 consult customer service for sensor request

### J OUTPUT LM/FT

**CS** 400lm/ft 100% ±      0 4 0 0 L F  
**CS** 600lm/ft 100% ±      0 6 0 0 L F  
**CS** 800lm/ft 100% ±      0 8 0 0 L F  
 Custom lm/ft      X X X X L F  
 custom lumen up to 1000 lm/ft

### K CIRCUIT / EM

**CS** Single circuit      \*  
 EMC night light circuit      N L C  
 EMB available in 4ft and 8ft      E M #  
 \* leave blank

### L SHAPE / PATTERN

**CS** Linear / straight      S T  
**CS** Linear / straight + flex inset S F  
 includes 1ft. field-cutable section; only available for 4' and 8' segments  
 L-shape      L S  
 □-shape (rectangular shape)      R S  
 U-shape      U S  
 Custom shape      X X

### M DIMENSIONS IN INCH

Linear 2'      2 4 I N  
**CS** Linear 4'      4 8 I N  
**CS** Linear 6'      7 2 I N  
**CS** Linear 8'      9 6 I N  
 Linear custom      # # # I N  
 Linear flex inset      # # # I N  
 field-cutable section  
 L-Shape      # # # X # # # I N  
 U-Shape      # # # X # # # X # # # I N  
 □-Shape      # # # X # # # I N



for lengths including flex insets, round up to the nearest total foot length

### N CERTIFICATION (optional)

Red List Approved      R L A

**BASO**  
 basolighting.com  
 xalusa.com

### Technical data

	SIZE TYPE	LED COLOR TEMPERATURE	INPUT WATTS	DELIVERED LM TOTAL	LIGHT DISTRIBUTION	DELIVERED LM DIRECT	DELIVERED LM INDIRECT	OPTICAL EFFICIENCY	LUMINAIRE EFFICACY	
<b>BASO DIRECT</b>										
	e LED	2' linear	40K	8.2W	800lm	100% down	400lm/ft	-	67%	98lm/W
		4' linear		16.4W	1610lm					
		8' linear		32.8W	3220lm					
		2' + 2' corner		16.4W	1610lm					
	e² LED	2' linear	40K	11.75W	1100lm	100% down	550lm/ft	-	67%	94lm/W
		4' linear		23.5W	2200lm					
		8' linear		47W	4410lm					
		2' + 2' corner		23.5W	2200lm					

for 30 K or 35 K multiply lm value by 0.96

### Patterns top view

#### LINEAR

A	FIXTURES	CODE
48"	1 × 4' linear	ST - 0 4 F T
96"	1 × 8' linear	ST - 0 8 F T
144"	3 × 4' linear	ST - 1 2 F T



#### L-SHAPE

A / B	FIXTURES	CODE
48" / 48"	2 × 2' linear + 1 × 2' × 2' corner	LS - 0 4 X 0 4 F T
48" / 96"	1 × 2' linear + 1 × 6' linear + 1 × 2' × 2' corner	LS - 0 4 X 0 8 F T
96" / 96"	2 × 6' linear + 1 × 2' × 2' corner	LS - 0 8 X 0 8 F T

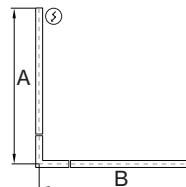

#### □-SHAPE (rectangular shape)

A / B	FIXTURES	CODE
48" / 48"	4 × 2' × 2' corner	RS - 0 4 X 0 4 F T
48" / 96"	2 × 4' linear + 4 × 2' × 2' corner	RS - 0 4 X 0 8 F T
96" / 96"	4 × 4' linear + 4 × 2' × 2' corner	RS - 0 8 X 0 8 F T

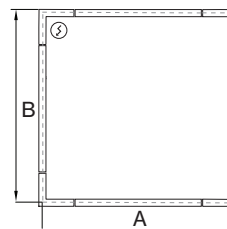

#### U-SHAPE

A / B / C	FIXTURES	CODE
48" / 48" / 48"	2 × 2' linear + 2 × 2' × 2' corner	US - 0 4 X 0 4 X 0 4 F T
48" / 96" / 48"	1 × 4' linear + 2 × 2' linear + 2 × 2' × 2' corner	US - 0 4 X 0 8 X 0 4 F T
48" / 144" / 48"	1 × 8' linear + 2 × 2' linear + 2 × 2' × 2' corner	US - 0 4 X 1 2 X 0 4 F T

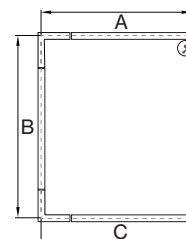

DIMENSIONS

**BASO 1.5**

SURFACE  
direct

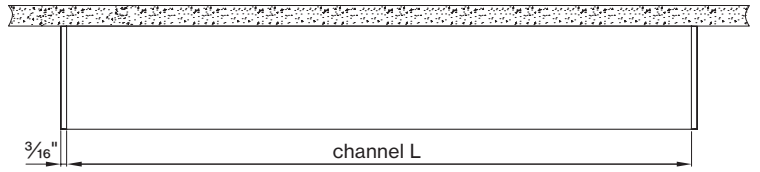
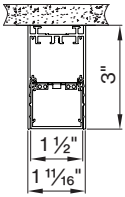

PENDANT  
direct

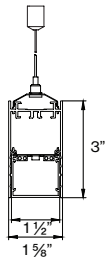

direct / indirect

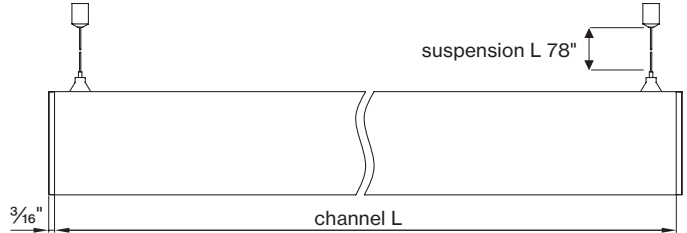
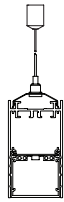

**BASO 1.5 SPECIALITY MOUNTING**

SURFACE  
in-line ACT TBAR

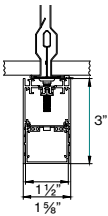

SURFACE  
in-line ACT SLOT

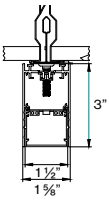

SURFACE  
ACT center tile

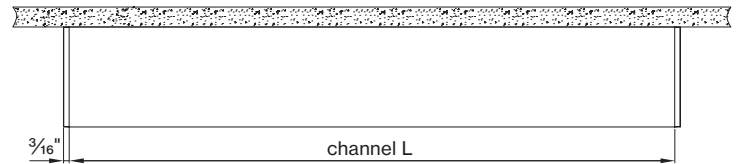
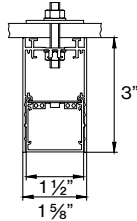

PENDANT  
ACT TBAR

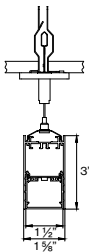

PENDANT  
in-line ACT SLOT

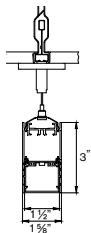

PENDANT  
ACT center tile

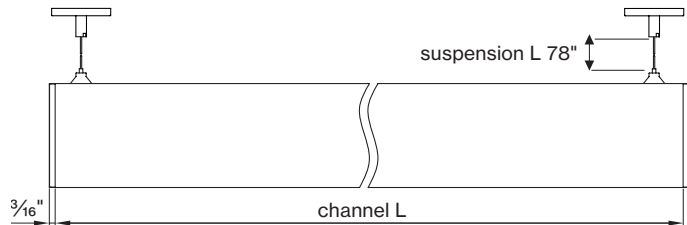
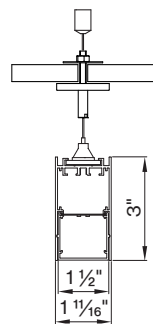

**BASO mounting instructions**

Get access to the BASO 1.5 mounting instructions faster by scanning the QR code.

[www.xalusa.com/resources/mounting-instructions/baso](http://www.xalusa.com/resources/mounting-instructions/baso)

